

Thank you for purchasing the Omron DuoBaby. This product was developed in conjunction with respiratory therapists for the successful treatment of asthma, chronic bronchitis, allergies, blocked nose, and other respiratory disorders. This is a medical device. Operate the device only as instructed by your doctor and/or respiratory therapist.

### How the nebulizer kit works

The medication that is pumped up through the medication channel is mixed with compressed air which is generated by a compressor pump. The compressed air mixed with medication is turned into fine particles and sprayed when in contact with the baffle.

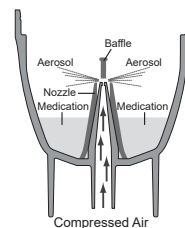

### How the nasal aspirator kit works

The compressed air generated by the compressor pump, passing through a narrowing, thanks to the Venturi effect, creates a vacuum which sucks the mucus into the collection chamber.

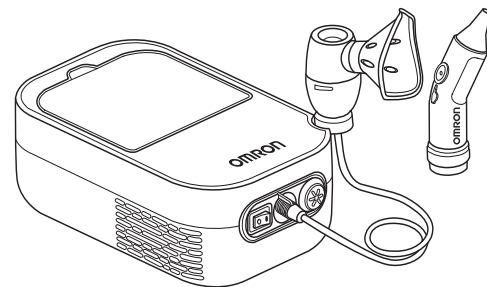
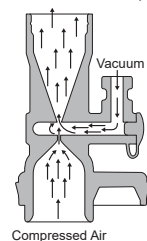

## Compressor Nebulizer with Nasal Aspirator

### DuoBaby (NE-C301-E)

## Instruction Manual

EN

	<b>3A HEALTH CARE S.r.l.</b> Via Marziale Cerutti, 90F/G 25017 Lonato del Garda (BS) Italy
<b>Distributor</b>	<b>OMRON HEALTHCARE EUROPE B.V.</b> Scorpius 33, 2132 LR Hoofddorp, THE NETHERLANDS www.omron-healthcare.com
<b>Subsidiaries</b>	<b>OMRON HEALTHCARE UK LTD.</b> Opal Drive, Fox Milne, Milton Keynes, MK15 0DG, UK www.omron-healthcare.com <b>OMRON MEDIZINTECHNIK HANDELSGESELLSCHAFT mbH</b> Konrad-Zuse-Ring 28, 68163 Mannheim, GERMANY www.omron-healthcare.com <b>OMRON SANTÉ FRANCE SAS</b> 14, rue de Lisbonne, 93561 Rosny-sous-Bois Cedex, FRANCE www.omron-healthcare.com

Made in Italy

### Know your unit

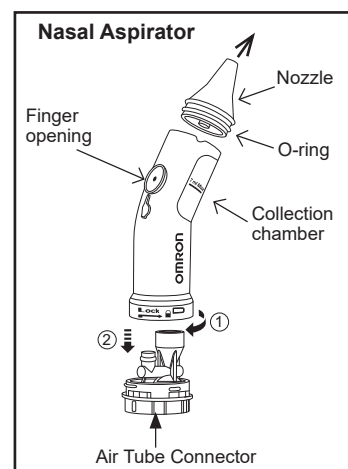
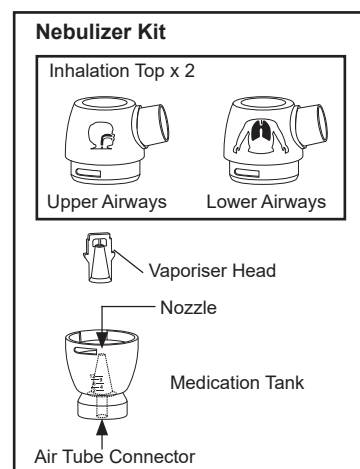
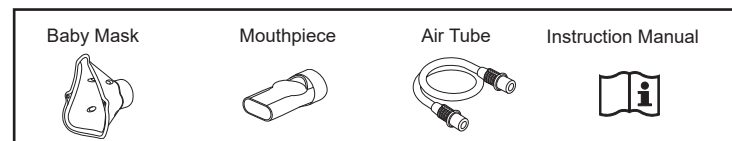
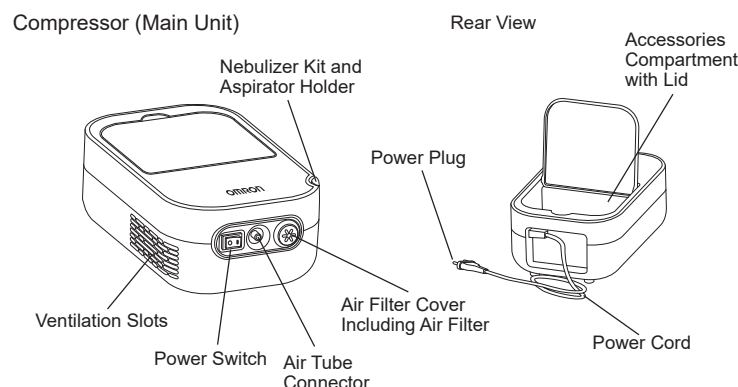

### Important safety instructions

- Warning:** Indicates a potentially hazardous situation which, if not avoided, could result in serious injury.
- A single-patient use is recommended.
  - Do not use the device for other use than nebulization for human aerosol therapy and for removing the mucus.
  - Manufacturer will not be held responsible for inappropriate use of the device.
  - Use only original OMRON accessories as indicated in this instruction manual.
  - The correct functioning of the device may be affected by electromagnetic interference caused by malfunctioning television sets, radios, etc. If this occurs, move the source of interference away from the device or use a different plug.
  - For type, dose, and regime of medication follow the instructions of your doctor or respiratory therapist. Before use check that you are using the correct Inhalation top.
  - If you feel or see anything unusual during use, stop using the device immediately and consult your doctor.
  - Do not use only water in the nebulizer for inhaling purposes.
  - Keep the device out of the reach of unsupervised infants and children. The device may contain small pieces that can be swallowed.
  - In view of their length, the power cord and air tube could constitute a strangulation hazard.
  - Do not store the air tube while there is moisture remaining inside.
  - Always dispose of any remaining medication after use, and use fresh medication each time.
  - Do not use in anaesthetic or ventilator breathing circuits.
  - Never block the ventilation slots. Never place the device where the ventilation slots may be obstructed during operation.
  - Never leave the nebulizer kit with medication near the ventilation slots, this is to avoid medication entering the device.
  - Store the parts in a clean location for avoiding infection.

### (Risk of electrical shock)

- Never plug or unplug the device with wet hands.
- The compressor and power cord are not waterproof. Do not spill water or other liquids on these parts. If liquid does spill on these parts, immediately unplug the power cord and wipe off the liquid.
- Do not immerse the compressor in water or other liquid.
- Do not use or store the device in humid locations.
- Do not operate the device with a damaged power cord or plug.
- Keep the power cord away from heated surfaces.
- Always unplug the device from the power outlet after use and before cleaning.
- Plug the device into the appropriate voltage outlet. Do not overload power outlets or use extension cords.
- Do not misuse the power cord.
- Do not wind the power cord around the compressor.
- Be sure to use the compressor at a place where the power plug is easily accessible during treatment.

### (Cleaning and disinfecting)

- Observe the rules below when cleaning or disinfecting parts. Failure to observe these rules may result in damage, inefficient nebulization or infection. For the instructions, refer to "Cleaning and daily disinfecting" section.
- Clean and disinfect the nebulizer kit, baby mask, mouthpiece and nasal aspirator before using them when as follows:
    - the first time after purchase
    - if the device has not been used for a long period of time
    - if more than one person uses the same device
  - Be sure to wash or wipe the parts after use, and ensure that they are thoroughly disinfected and dried, and stored in a clean location.
  - Do not leave the cleaning solution in the parts.
  - Do not use a microwave oven, dish dryer or hair dryer to dry the device or the parts.
  - Do not use an autoclave, EOG gas sterilizer or low temperature plasma sterilizer.
  - When disinfecting parts by boiling, make sure that the container does not boil dry. Otherwise it may also result in fire.

**Caution:** Indicates a potentially hazardous situation which if not avoided, may result in minor or moderate injury, or physical damage.

### General Safety Precautions:

- Inspect the device and parts before using them each time, and check that there are no problems. In particular, be sure to check the following:
  - That the nozzle of either the nebulizer kit or aspirator or air tube are not damaged or blocked.
  - That the compressor operates normally.
- When using this device, there will be some noise and vibration caused by the device. This is normal and does not indicate a malfunction.
- Do not use if the device or any parts are damaged. Replace damaged parts.
- Do not subject the device or the parts to any strong shocks such as dropping the device on the floor.
- Do not insert objects inside the compressor.
- Do not disassembly or attempt to repair the compressor or power cord.
- Do not leave the device or its parts in extreme hot or cold temperature, or under direct sunlight.

Keep these instructions for future reference.

### (Nebulizer: Usage)

- Provide close supervision when this device is used by, on, or near children, invalids or persons who cannot express their consent.
- Make sure that the parts are attached or installed correctly.
- Make sure that the air filter is clean and correctly attached. If the air filter has been used for more than 70 applications, replace it with a new one.
- Do not tilt the nebulizer kit at an angle of greater than 60 degrees in all directions or shake it while in use.
- Do not use or store the device while the air tube is creased.
- Do not add more than 12 ml of medication to the medication tank.
- Do not carry or leave the nebulizer kit while the medication tank contains medication.
- This product should not be used on patients, who are unconscious, sleeping, are drowsy or are not breathing spontaneously.
- Do not distort the vaporiser head, or jab the nozzle of the medication tank with a pin or any sharp object.
- The compressor may become warm during operation, therefore do not touch it other than turning it off after nebulizing.
- To avoid medication residue on the face, be sure to clean the patient's face after removing the mask.

### (Nasal Aspirator: Usage)

- The nasal aspirator should be used exclusively for removing the nasal mucus from a baby's nose. It cannot be used for any other purpose.
- Do not obstruct the holes on the bottom of the nasal aspirator.
- If you notice rashes or redness appearing, inside or around the nose of the baby during or after using the device or anything unusual during use, stop using the device and consult a physician.
- Only use the original parts as included in the product.
- Do not attach the nasal aspirator to any other device.



### DISPOSAL PROCEDURE (Dir. 2012/19/EU-WEEE)

This product is not to be treated as regular household waste but must be returned to a collection point for recycling electric and electronic devices. Further information is available from your municipality, your municipality's waste disposal services, or the retailer where you purchased your product.

### Important information regarding Electro Magnetic Compatibility (EMC)

NE-C301-E manufactured by 3A HEALTH CARE S.r.l. conforms to EN60601-1-2:2015 Electro Magnetic Compatibility (EMC) standard. Further documentation in accordance with this EMC standard is available at OMRON HEALTHCARE EUROPE at the address mentioned in this instruction manual or at www.omron-healthcare.com. Refer to the EMC information for NE-C301-E on the website.

### Optional Medical Accessories

(within the scope of EC Medical Device Directive 93/42/EEC)

Product description	Model
DuoBaby Nebulizer accessory set (contents: nebulizer kit (includes two inhalation tops), baby mask, adult mask, mouthpiece, 3 air filters, air tube)	NEB2012
DuoBaby Aspirator accessory set, (contents: nasal aspirator, air tube)	NEB7000

### Other Optional/Replacement Parts

Product description	Model
Air Filter set (contents: 3 pieces)	3AC408



### User Guidance about the Nebulizer Kit

The DuoBaby nebulizer is a medical device that generates an aerosol with adjustable characteristics to adapt to the patient's respiratory pathology

#### Inhalation Top 1 – Green Color for Upper Airways:

Treats conditions such as: rhinitis, sinusitis, pharyngitis, tonsillitis, and laryngitis.

Particle size (MMAD) is approximately 9 µm.



#### Inhalation Top 2 – Blue Color for Lower Airways:

Treats conditions such as: asthma, bronchitis, bronchiolitis, bronchiectasis and bronchopneumonia.

Particle size (MMAD) is approximately 4 µm.



### How to use nebulizer kit

1. Make sure that the power switch is in the off (○) position.
2. Plug the power plug into a power outlet.
3. Remove the inhalation top from the medication tank.
  - 1) Rotate the inhalation top anti-clockwise
  - 2) Lift the inhalation top out from the medication tank.

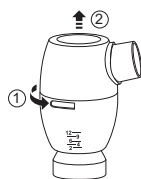

4. Add the correct amount of prescribed medication into the medication tank.

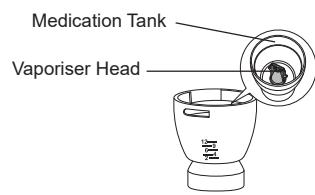

5. Verify the presence of the vaporiser head inside the medication tank.

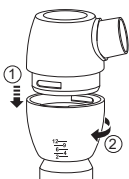

6. Choose the appropriate inhalation top by reading the "User Guidance". To put the inhalation top back onto the medication tank.
  - 1) Lower the inhalation top onto the medication tank.
  - 2) Rotate the inhalation top clockwise.

7. Attach the Baby mask or mouthpiece to the nebulizer kit tightly.

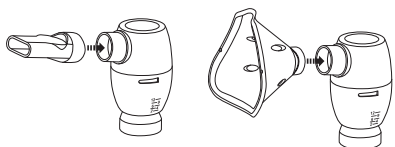

8. Attach the air tube. While twisting the air tube plug slightly, push it firmly into the air tube connector.

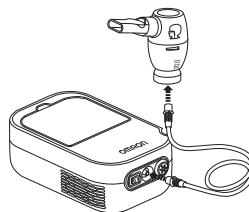

9. Hold the nebulizer kit as indicated on the right. Follow the instructions of your doctor or respiratory therapist.

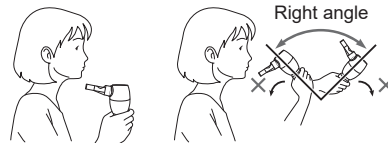

#### Caution:

Do not tilt the nebulizer kit at an angle of greater than 60 degrees in all directions. Medication may flow into the mouth or it may result in ineffective nebulization.

10. Turn the power switch to the on (I) position. As the compressor starts, nebulization begins and aerosol is generated. Inhale the medication. Exhale through the nebulizer kit.

11. When treatment is completed, turn the power off and unplug the compressor from the power outlet.

12. Clean and disinfect all (disassembled) parts according to the "Cleaning and daily disinfecting" section.

### How to use Nasal Aspirator

Dry and very thick mucus inside the nose may be dissolved by saline solutions. After adding saline solution into each nostril of the baby's nose to help loosen nasal secretions, wait a few minutes and then remove the mucus running out with a tissue. Only after removing the running mucus outside the nostrils the nasal aspirator may be used.

1. Make sure that the power switch is in the off (○) position.
2. Assemble the nasal aspirator. Make sure that the O-ring is properly attached. Refer to the drawing "Nasal Aspirator".
3. Plug the power plug into a power outlet.
4. Connect the air tube to the nasal aspirator and to the main unit, while twisting the air tube plugs slightly, push them firmly.



5. Keep your baby in a comfortable position and make sure that their head is lifted as shown on the figure to the right.

6. Turn the power switch to the on (I) position. Place your index finger over the opening on the nasal aspirator, as shown on the figure to the right to begin aspiration.

#### Caution:

Before using the nasal aspirator, try it on the hand to see if it sucks. When functioning properly, there must be a slight suction from the nozzle. If air is exiting from the nozzle, do not continue using the aspirator.

While using, the aspirator needs be in the upright position, with the finger opening on top (see figure by above). This prevents the sucked mucus from entering parts other than the collection chamber.

7. Place the nozzle at the entrance of one of the nostrils of the baby. (do not insert inside the nostril). Use the aspirator for 3 seconds for 4 times per nostril.
8. When treatment is completed, turn the power off and unplug the compressor from the power outlet.
9. Disconnect the aspirator from the air tube and disassemble it into 3 parts as shown in "Know your unit"; clean or disinfect according to the section below.



### Cleaning and daily disinfecting

#### Cleaning

Clean the parts after each use to remove residual medication or mucus. This will prevent inefficient nebulization or aspiration and reduce the risk of infection. Do not use a brush or pin to clean.

- Washable parts: **Nebulizer kit, Baby Mask (PVC), Nasal Aspirator, Mouthpiece**  
Wash them in warm water and mild, neutral detergent. Rinse them thoroughly with clean hot tap water, gently tap to remove excess water and allow to air dry in a clean place. It is advisable to replace the DuoBaby nebulizer kit or nasal aspirator after some 100 to 120 treatments or after about 20 boiling cycles.

- Non-washable parts: **Compressor, Air Tube (PVC)**  
Firstly, make sure that the power plug is unplugged from the power outlet. Wipe clean with a soft cloth, moistened with water or mild, neutral detergent.

**Air Filter**  
Do not wash or clean the air filter. Refer to "Changing the air filter" section.

#### Disinfecting

Always disinfect the parts after the last treatment of the day. If the parts are heavily stained, replace them with new ones. To select a method for disinfection, refer to the table below.

○: applicable X: not applicable

Disinfecting method	Parts	Mouthpiece	Nasal Aspirator	Nebulizer Kit	Baby Mask**	Air Tube	Air Filter
	Materials	PP	PP	PP	Mask: PVC (Phthalate free)	PVC (Phthalate free)	
<b>A</b> See notes below	Disinfecting ethanol	○	○	○	○	X	X
	Sodium hypochlorite	○	○	○	○	X	X
	Milton*	○	○	○	○	X	X
	Quaternary ammonium	○	○	○	○	X	X
	Osvan*	○	○	○	○	X	X
	Chlorhexidine	○	○	○	○	X	X
	Hibitane*	○	○	○	○	X	X
<b>B</b>	Amphoteric Surfactant	○	○	○	○	X	X
	Tego*	○	○	○	○	X	X
<b>B</b>	Boiling	○	○	○	X	X	X

\* An example of commercially available disinfectant.

\*\* Elastic band (non-latex). Do not disinfect.

#### Notes:

- Use a commercially available disinfectant. Follow the instructions provided by the disinfectant manufacturer.
- Never clean with benzene, thinner or a flammable chemical.
- After having washed the Nebulizer Kit and/or Nasal Aspirator with the available disinfectant, please rinse with clean warm water and dry thoroughly before using.
- Applicable parts may be boiled between 15 to 20 minutes.
- After boiling, carefully remove the parts, shake off excess water and allow to air dry in a clean environment.

### Removing condensation from the air tube

If there is moisture remaining in the air tube, be sure to follow the procedure below.

- Make sure that the air tube is connected to the air connector on the compressor.
- Remove the air tube from the nebulizer kit or the nasal aspirator.
- Turn on the compressor and pump air through the air tube to expel the moisture.

### Changing the air filter

If the air filter has changed colour, or has been used for more than 70 applications, replace it with a new one. (see Other Optional / Replacement Parts).

1. Remove the air filter cover as shown in figure.
2. Remove the old air filter with a sharp object, such as a toothpick, and insert the new air filter.
3. Put the air filter cover back in place.

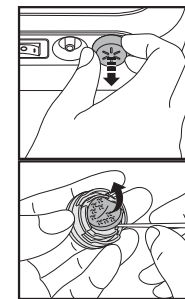

#### Notes:

- Use only OMRON air filters designed for this device. Do not operate without a filter.
- Do not attempt to wash or clean the filter. If the air filter becomes wet, replace it. Damp air filters can cause blockages and may increase risk of infection.
- There is no front or back orientation for the air filters.
- Check that air filters are clean and free of dust before inserting them.

### Troubleshooting for: main unit, nebulizer kit and nasal aspirator

Check the following if the device should fail before or during operation.

Problem	Cause	Remedy
Nothing happens when the power switch is turned.	Is the power plug plugged into a power outlet?	Check that the plug is inserted in a power outlet. Unplug then reinsert the plug if necessary.
No nebulization/ aspiration or low nebulization, when the power is on.	Is there sufficient medication in the medication tank? (only nebulizer kit)	Add the correct amount of medication to the medication tank.
	Is the vaporizer head missing or not assembled correctly? (only nebulizer kit)	Attach the vaporizer head correctly.
	Is the nebulizer kit or nasal aspirator assembled correctly?	Assemble the nebulizer kit or nasal aspirator correctly.
	Is the nozzle for the nebulizer kit or aspirator blocked?	Make sure that the nozzle is free of blockages, do not pinch the nozzle.
	Is the nebulizer kit or nasal aspirator tilted at a sharp angle?	Make sure that the nebulizer kit is tilted at an angle less than 60 degrees, or the aspirator is upright.
	Is the air tube connected correctly?	Make sure that the air tube is correctly connected to the compressor and nebulizer kit or nasal aspirator.
The compressor is abnormally loud.	Is the air tube folded, blocked or damaged?	Make sure that the air tube does not contain kinks or is not damaged or blocked.
	Is the air filter dirty?	Replace the air filter with a new one.
The compressor is very hot.	The compressor is insufficiently ventilated.	Attach the air filter cover correctly.
		Do not cover the compressor during use. Do not block the ventilation slots. Do not use the device in an environment with temperatures higher than 40°C.
The compressor suddenly stops during use.	The thermal cut-out has shut the device down due to overheating	See note below.
<b>Note:</b> Do not attempt to repair the device. Do not open and/or tamper with the device. No parts of the device are user serviceable. Return the device to an authorized OMRON retail outlet or distributor.		

### Technical data

Product Description:	Compressor Nebulizer with Nasal Aspirator
Model (code):	DuoBaby (NE-C301-E)
Rating:	230 V ~ 50 Hz
Power Consumption:	140 VA
Operating Temperature/ Humidity/Air Pressure:	+10°C to +40°C / 10% to 95%RH / 690 - 1060 hPa
Storage and Transport Temperature/Humidity/ Air Pressure:	-20°C to +70°C / 5% to 95%RH / 690 - 1060 hPa
Weight:	Approx. 1.7 kg (compressor only)
Dimensions:	Approx. 170 (W) x 280 (D) x 105.5 (H) mm
Contents:	Compressor, Nebulizer Kit, Air tube, Mouthpiece, Baby Mask, Nasal Aspirator, Instruction Manual.

= Class II equipment

= Type BF applied part

= Power off

Consult the instructions for use

IP 21 = Ingress Protection

= Power on

Alternating current

0051

### Nebulizer Kit

Appropriate Medication Quantities:	1 ml minimum - 12 ml maximum
Sound:	Noise level (at 1 m distance) 63 dB
	Nebulizer Upper Airways Lower Airways
Particle Size (MMAD*):	Approx. 9 µm Approx. 4 µm
Nebulization Rate (by weight loss):	Approx. 0.4 ml/min Approx. 0.2 ml/min
Aerosol Output (3 ml, 1% NaF):	Approx. 0.54 ml Approx. 0.50 ml
Aerosol Output Rate (1% NaF):	Approx. 0.16 ml/min Approx. 0.12 ml/min

\*MMAD = Mass Median Aerodynamic Diameter

Result of cascade impactor measurements for particle size

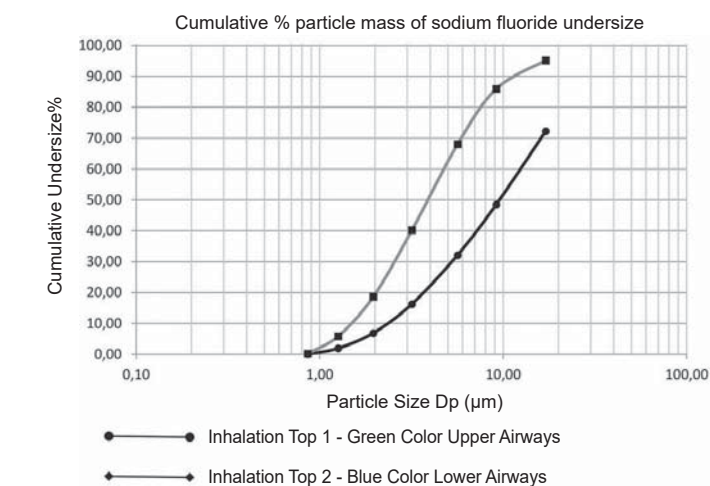

### Nasal Aspirator

Suction Pressure:	Minimum -0.15 bar - Maximum -0.2 bar
Air Flow:	Approx. 4 l/min
Maximum fill volume of collection chamber:	7 ml

#### General Notes:

- Subject to technical modification without prior notice.
- The device may not work if the temperature and voltage conditions are different to those defined in the specifications.
- The device fulfils the provisions of the EC directive 93/42/EEC (Medical Device Directive) and the European Standard EN13544-1:2007+A1:2009, Respiratory therapy equipment - Part1: Nebulizing systems and their components.
- Performance may vary with drugs such as suspensions or high viscosity. See drug supplier's data sheet for further details.
- IP classification is degrees of protection provided by enclosures in accordance with IEC 60529. The compressor is protected against solid foreign objects of 12.5 mm diameter and greater such as a finger, and against vertically falling water drops which may cause issues during a normal operation.
- See website of OMRON HEALTHCARE EUROPE for complete up to date information. URL: [www.omron-healthcare.com](http://www.omron-healthcare.com)

### Warranty

Thank you for buying an OMRON product. This product is constructed of high quality materials and great care has been taken in its manufacturing. It is designed to give you a high level of comfort, provided that it is properly operated and maintained as described in the instruction manual.

This product is guaranteed by OMRON for a period of 3 years after the date of purchase. The proper construction, workmanship and materials of this product is guaranteed by OMRON. During this period of guarantee OMRON will, without charge for labour or parts, repair or replace the defect product or any defective parts. The guarantee does not cover any of the following:

- Transport costs and risks of transport.
- Costs for repairs and / or defects resulting from repairs done by unauthorised persons.
- Periodic check-ups and maintenance.
- Failure or wear of optional parts or other attachments other than the main device itself, unless explicitly guaranteed above.
- Costs arising due to non-acceptance of a claim (those will be charged for).
- Damages of any kind including personal caused accidentally or from misuse.

Should guarantee service be required please apply to the dealer whom the product was purchased from or an authorised OMRON distributor. For the address refer to the product packaging / literature or to your specialised retailer.

If you have difficulties in finding OMRON customer services, contact us for information. Repair or replacement under the guarantee does not give rise to any extension or renewal of the guarantee period.

The guarantee will be granted only if the complete product is returned together with the original invoice / cash ticket issued to the consumer by the retailer. OMRON reserves the right to refuse the guarantee service if any unclear information has been given.